



Model WB9038-P Wheelbarrow

- Thank you for purchasing our WB9038-P.
- If you have any questions or comments please call us or email us at customerservice@mastergardner.com
- Phone: (864) 574-7868
- The Master Gardner Company
5770 N. Blackstock Rd.
Spartanburg, SC 29303
www.mastergardner.com



Installation Instructions

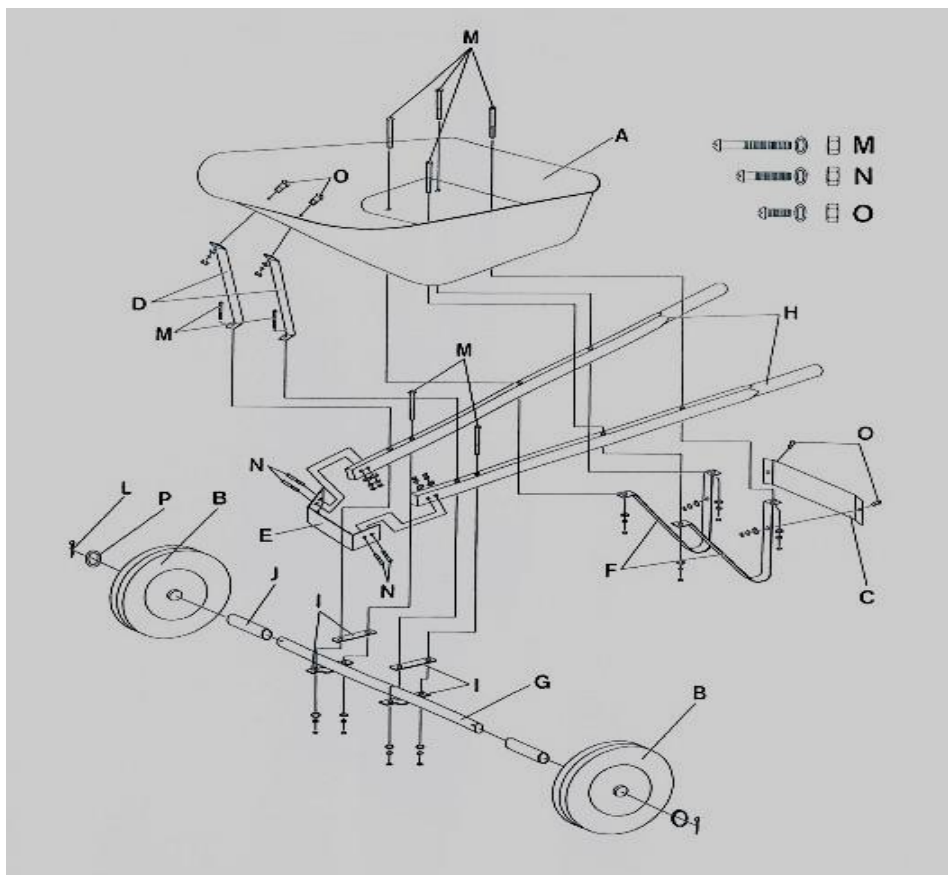











PARTS & HARDWARE IDENTIFICATION

A.	Tray	1 PC
H.	Handle	2 PCS
F.	Leg	2 PCS
O.	Leg Brace	1 PC
D.	Front support	2 PCS
E.	U shape bracket	1 PC
J&I.	Ω shape bracket	2 PCS
G.	Axle	1 PC
B.	Wheel	2 PC



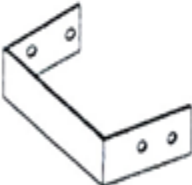

HARDWARE DESCRIPTION QTY

N.	DIAXL:8X40mm Bolt	4 PCS	For U shape bracket
M.	DIAXL:8X65mm Bolt	8 PCS	For Tray and Ω shape bracket
O.	DIAXL: 8X25mm Bolt	6 PCS	For Front support & leg brace
P.	20MMFLAT WASHER	4 PCS	
L.	2.5X35MM PIN	2 PCS	
	NUT DIA:8MM	18 PCS	
	WASHER DIA:8MM	18 PCS	

PART LIST

KEY	PART	DESCRIPTION	QTY.	KEY	PART	DESCRIPTION	QTY.
A		Tray	1	F		Leg	2
B		Wheel	2	G		Alex	1
				H		Steel Handle	2
C		Leg Brace	1	I		Wheel Bracket	2
D		Tray Brace	2				
E		Nose Guard	1	L		Axle Pin	2

HARDWARE LIST

M		M8X75mm Bolt	8	O		M8X25MM Bolt	6
N		M8X40mm Bolt	4	P		Large Washer	4



- A few **important points** before starting your assembly.
 - Please only hand tighten all nuts until the assembly has been completed.
 - If you have any questions or comments, Please do not return to the store you purchased but contact The Master Gardner Company at (864) 574-7868 or customerservice@mastergardner.com
 - **On behalf of all the employees at The Master Gardner Company we Thank You for your purchase.**



- At this point you should have opened up the parts box and determined that all the parts are present and appear to be in good working condition.
- **Step 1**
- Please open the parts bag and lay out the bolts and nuts by largest to smallest.
- **Step 2**
- Take two of the longest bolts (75mm) and insert them through the bottom of the wheelbarrow bed, through the wheelbarrow handle, through the wheelbarrow support leg and place a locknut on the exposed bolt.
- Hand tighten only.
- Repeat on the other side, and this will have the bed, on the handles, with the leg braces attached.
- At this point the handles, and legs should be attached to the bed of the wheelbarrow.
- You will now attach the brackets that hold the axle and pneumatic tire in place as well the front “U” shaped nose bracket.



- **Step 3**

- Take one of the axle brackets and on the second hole on top of the wheelbarrow handle on you insert a (75 MM) bolt through the front support bracket, through the handle and through the axle bracket. On the bolt protruding you place a locknut. Hand tighten only.
- On the first hole on the top of the wheelbarrow handle closest to the tip you place a (75 mm) bolt through the top of the handle, through the axle bracket and hand tighten with a locknut.
- Now Place the axle and wheel through the axle bracket.
- Repeat step on other side to completely install the axle bracket with axle and wheel.
- **Hand tighten only.**
- After you have attached the axle and tire you will now put the “U” shaped nose guard with 40 mm bolts. You place the 40 mm bolt through the “U” bracket (nose guard), through the handle and place a locknut on the end. Repeat step until the “U” bracket is in place.



- **Step 4**

- On the holes that are in the front of the bed for front support of the wheelbarrow you will put the bolts (25 MM) in length. There are (2) 25 mm bolts, one to hold either support to the bed.
- **Hand tighten only.**

- **Step 5**

You will now install the cross supports that go on the leg brace of the wheelbarrow.

You should have two supports and (2) (40 mm) bolts.

The bolt goes through the cross support, through the base/support leg and on the end you install a locknut.

You now have installed the base/cross support legs.

Your wheelbarrow should be assembled.

It is now time to tighten up all the nuts completely.

We hope you have “**loads**” of fun with your new wheelbarrow and please visit our website at www.mastergardner.com for all of our exciting lawn and garden products.

